

sinus

park bench

sinus

slim trapezium



sinus

Expanding the original concept of tree grates Sinus, it was created a number of separate benches with an unmistakable expression. Strong steel plates easily bent on a slightly trapezoidal profile as in the case of the longest bench reinforced with an almost invisible rib rendering a totally solid shape. The dot perforation is a throwback to the genuine aesthetics of the 1960s. The combination with a unique seat pattern Cit.pin with plastic 'button pads' thermally isolates the unpleasantly cold metal while providing the ultimate sitting comfort. A subtle yet important detail is the option of having the bench optically "grow" right out of the pavement.

The galvanized steel sheet structures are also available cured with powder coating or left without surface finish. The Citépin seat thermally isolates the steel surface and thus provides superior comfort.

sinus



sinus



sinus



sinus

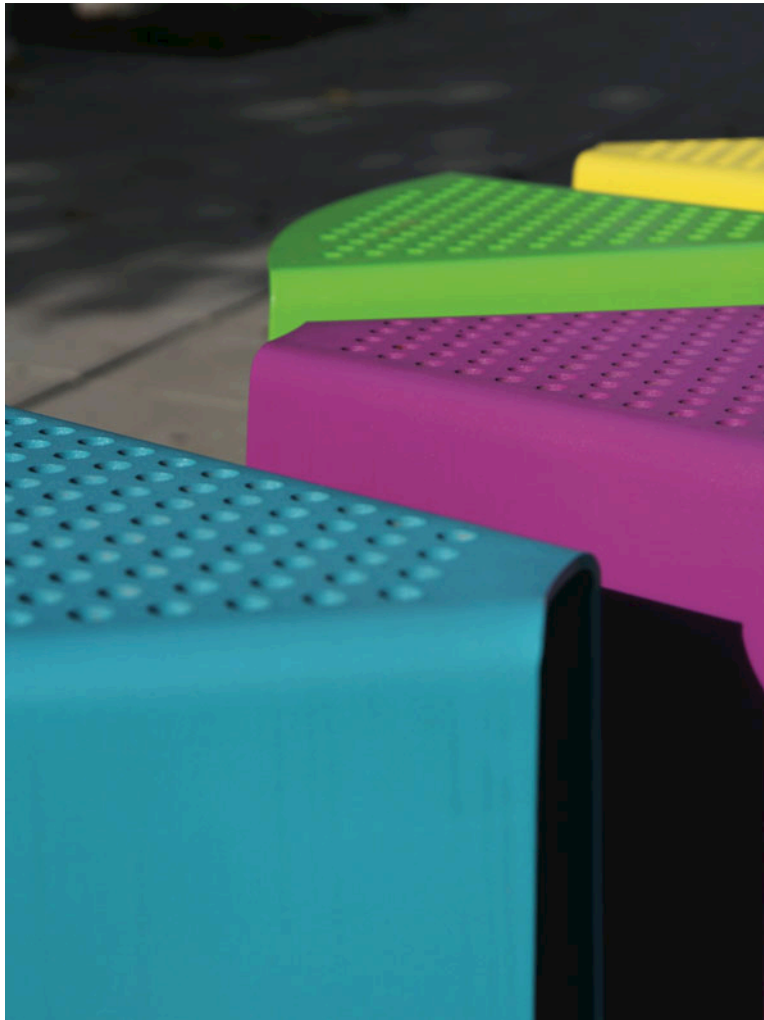

sinus

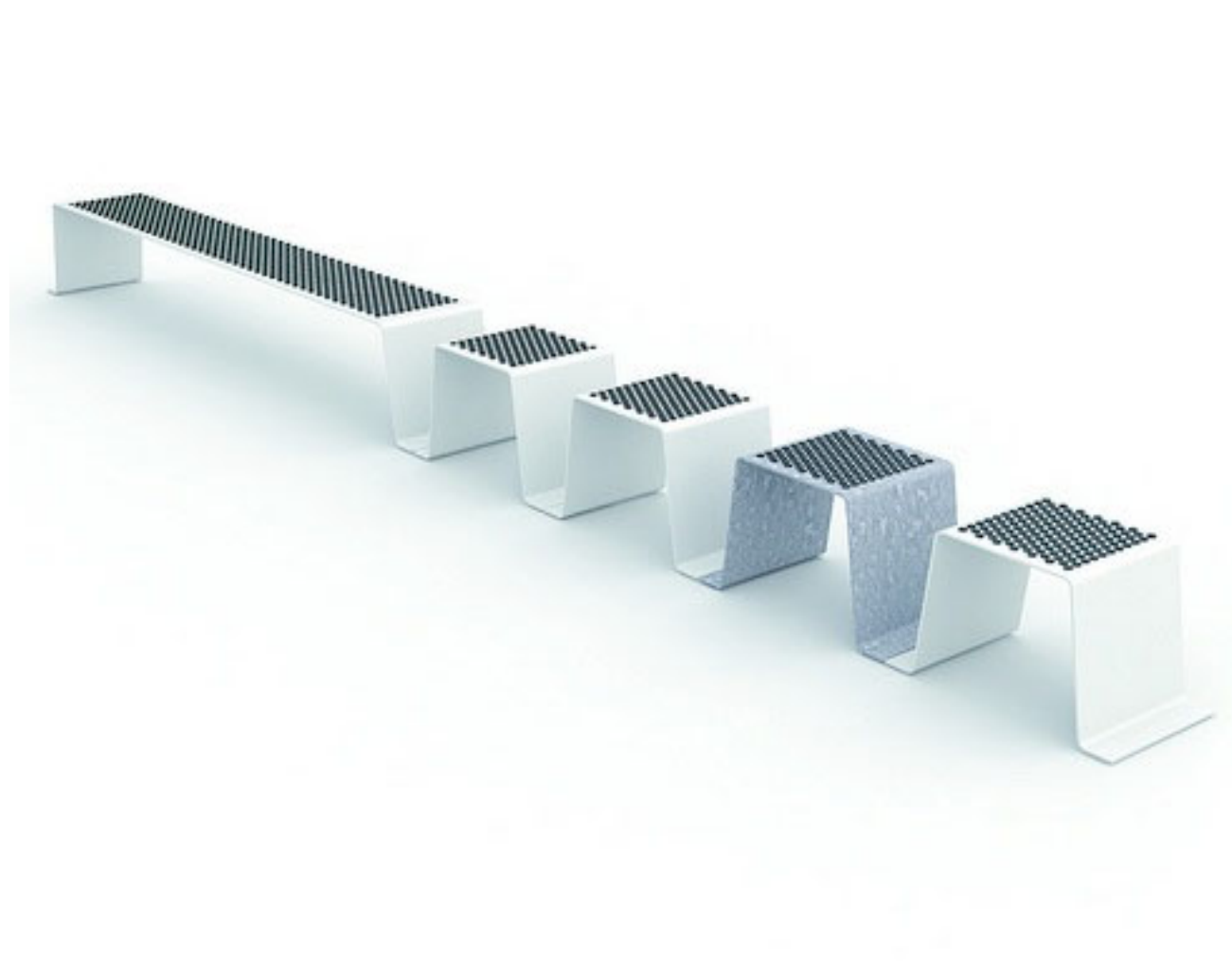
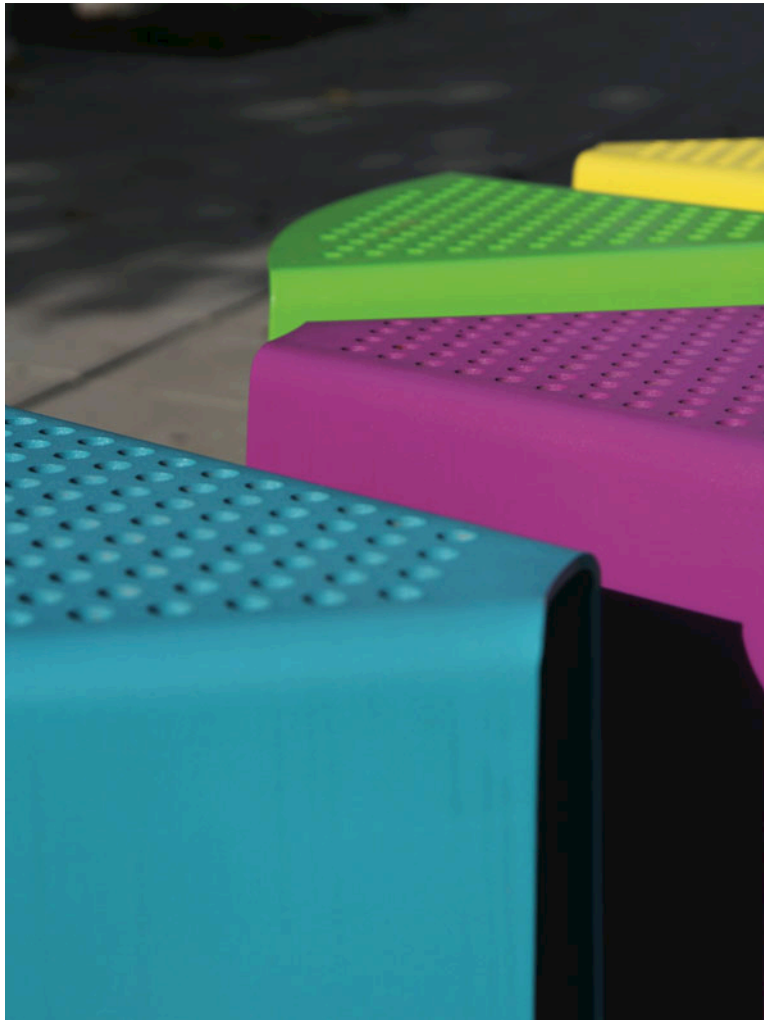



LSN110 / 115 / 210 / 215

Stool / Seating components

steel structure, seat made of perforated steel sheet, possibly Citépins

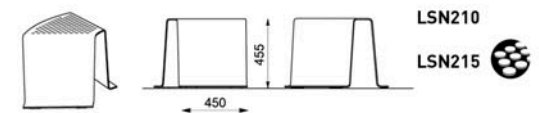
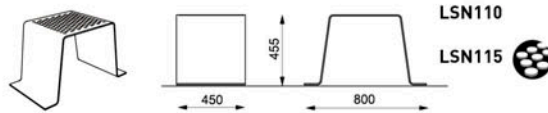

LSN130 / 135

Park bench

steel structure, seat made of perforated steel sheet, possibly Citépins

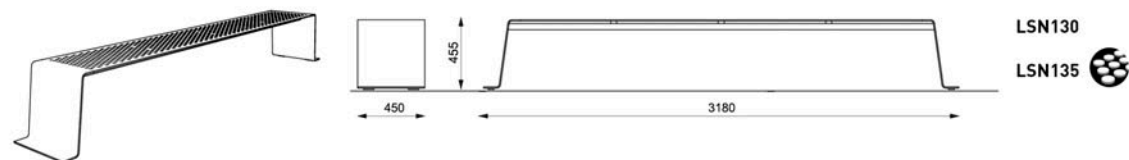

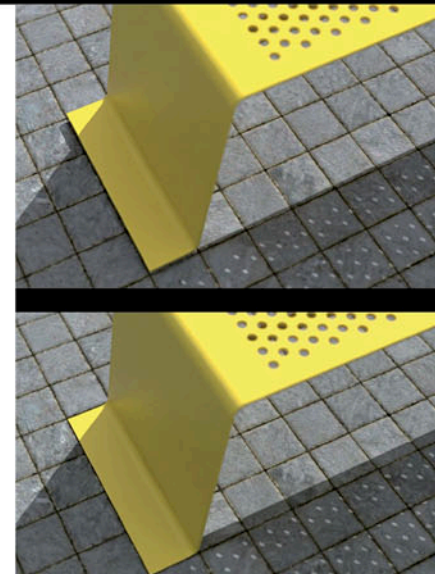
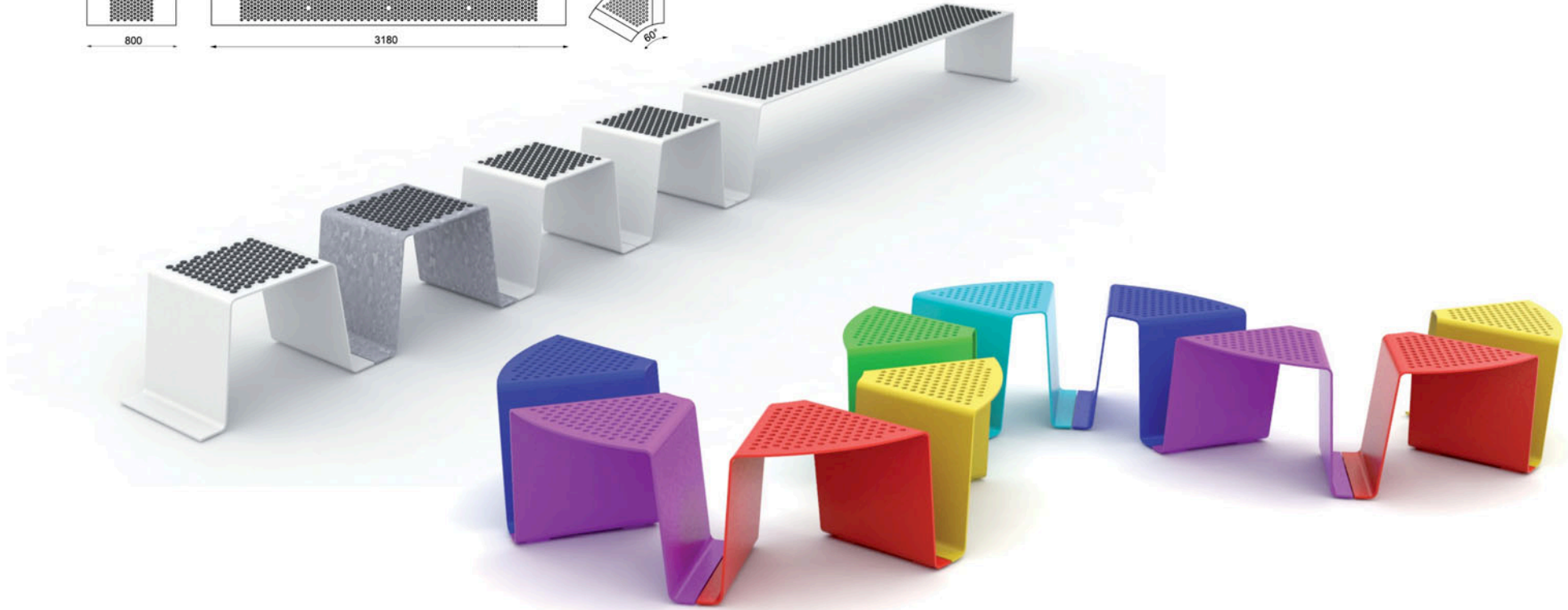
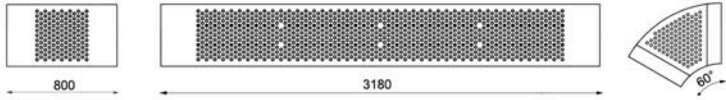

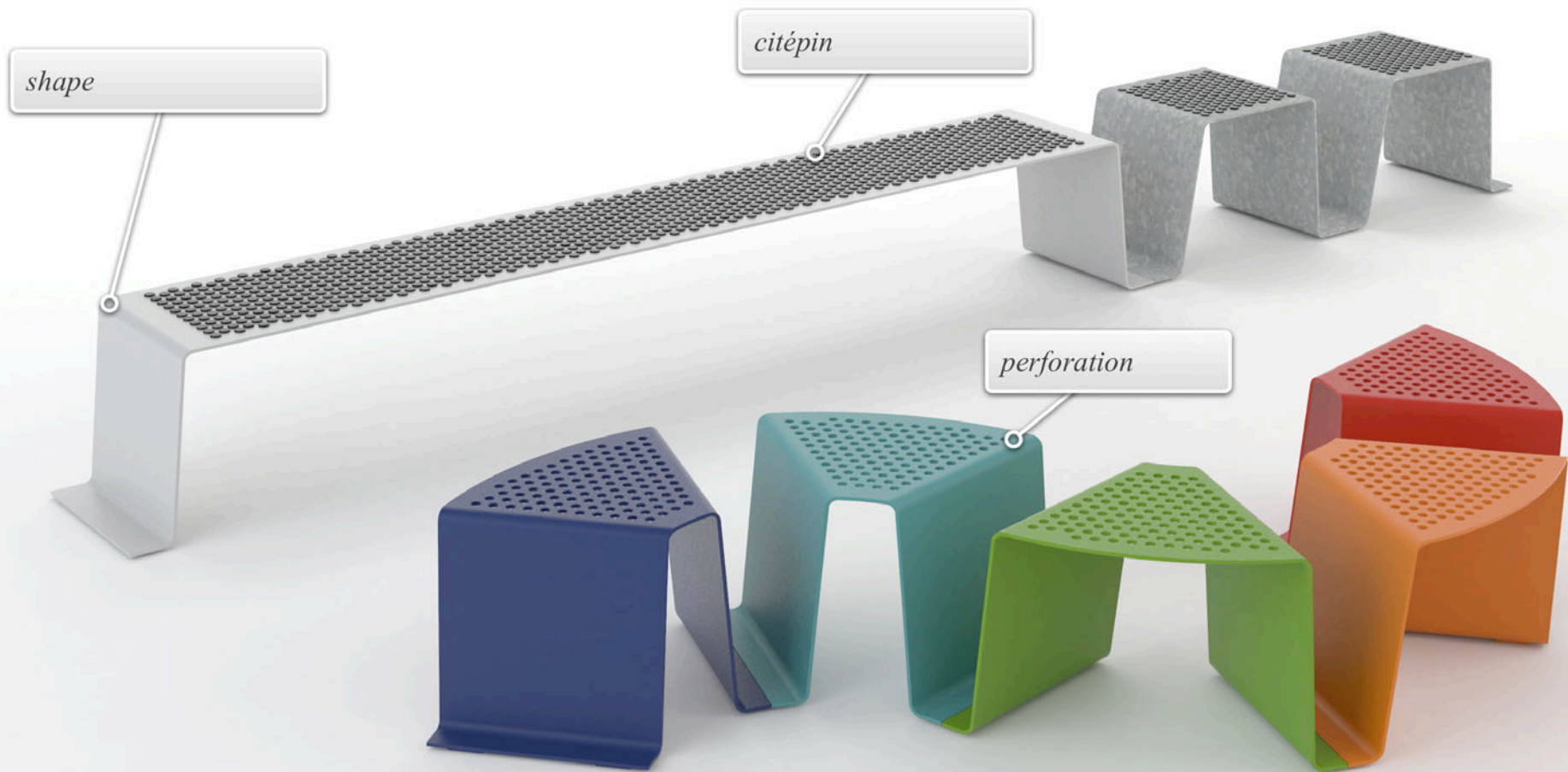

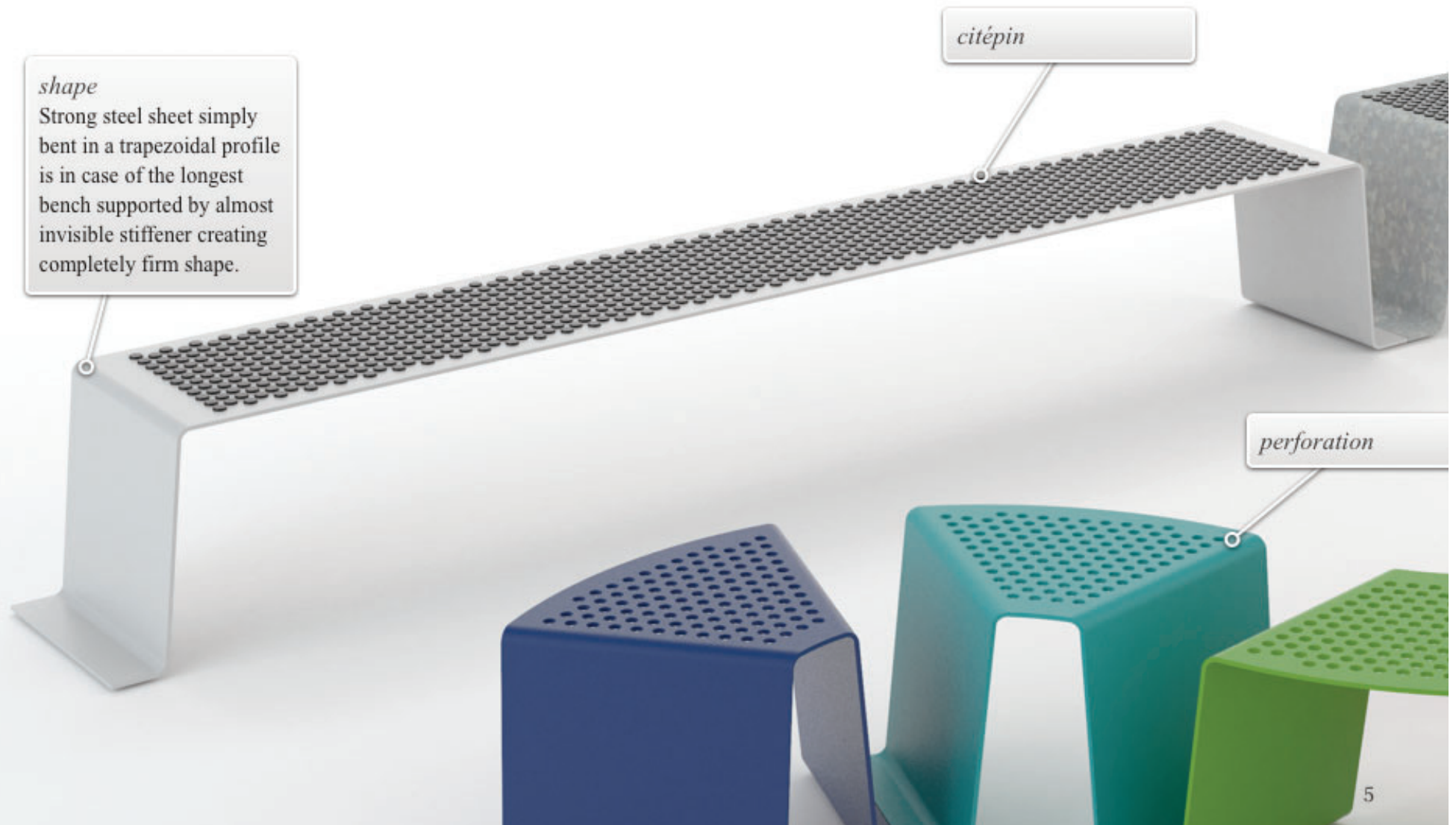

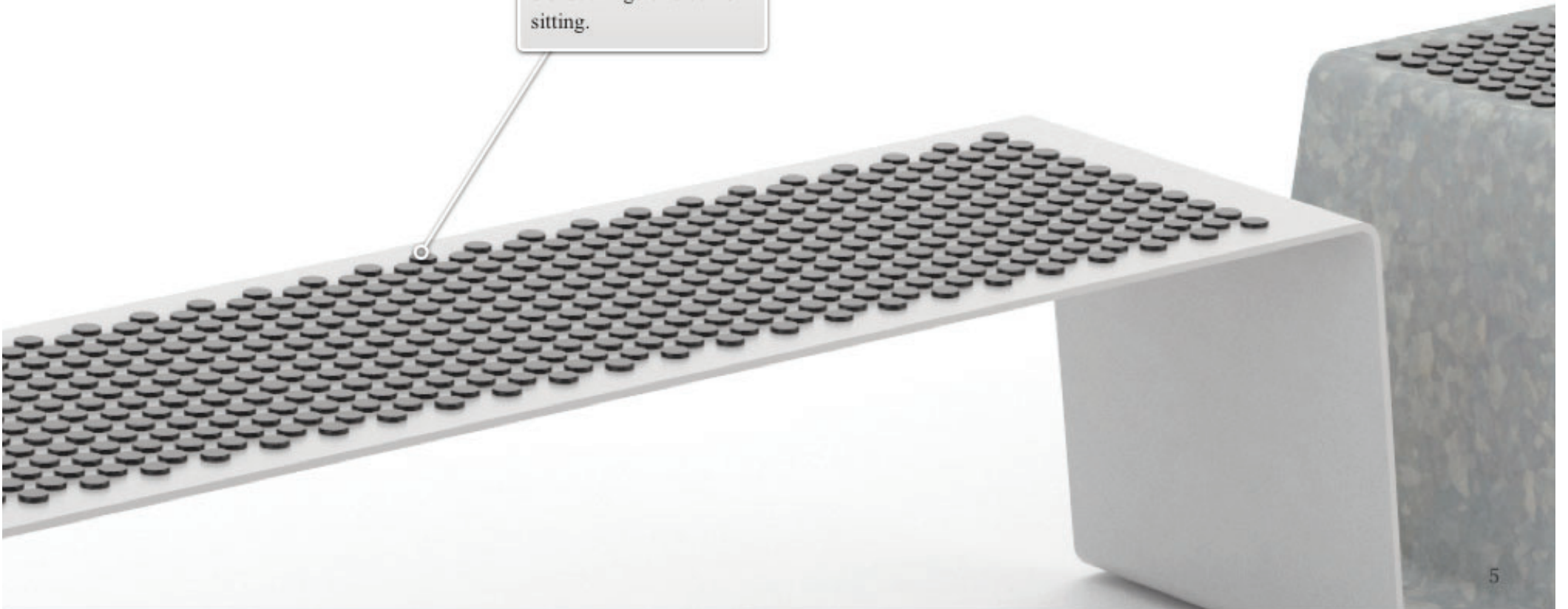

citépin

Plastic plugs eliminate
the coldness
disadvantage of steel for
sitting.





perforation
Dot perforation
refers to the
authentic aesthetics
of the sixties.

LSN110/115

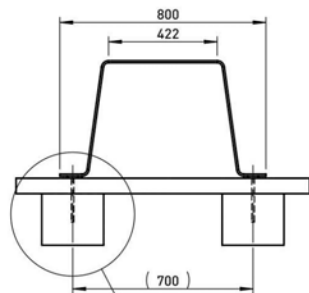

LSN130/135

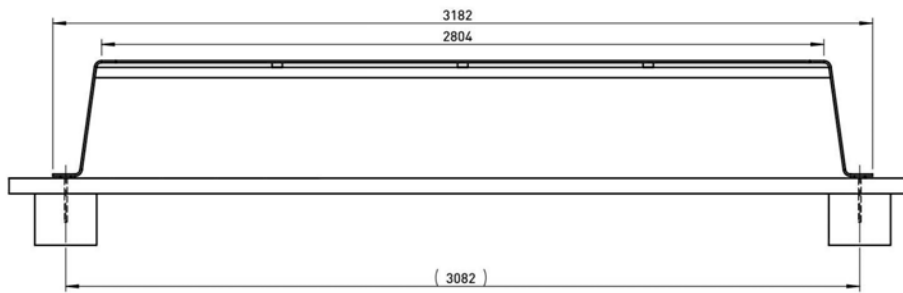

SKLÁDÁNÍ PŘÍMÝCH LAVIČEK
ASSEMBLING THE STRAIGHT BENCHES
ZUSAMMENSETZUNG VON DER GERADEN PARKBÄNKE

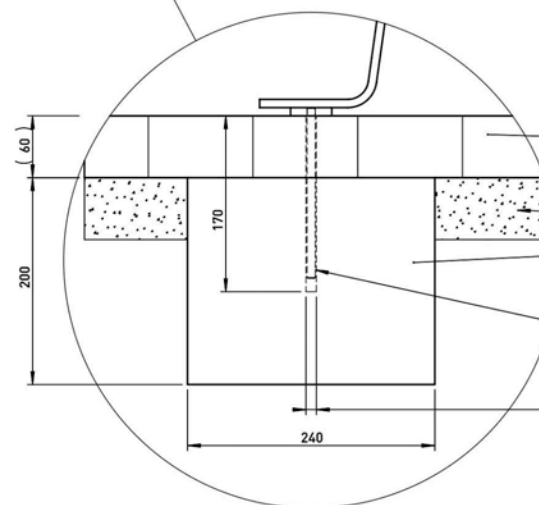
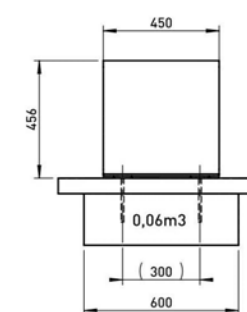
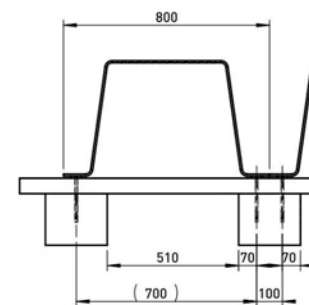

DLAŽBA / PAVEMENT / PFLASTERUNG

PODSYP / GRAVEL SUB-BASE / KIES UNTERGRUND

BETON / CONCRETE C12/15

CHEMICKÁ KOTVA M8x165
CHEMICAL ANCHOR
CHEMISCHER ANKER

Ø 10
PRŮMĚR VRTÁNÍ
DRILL DIAMETER
BOHRDURCHMESSER

LSN210/215

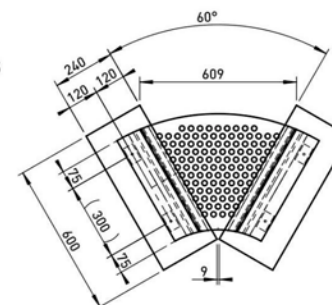

SKLÁDÁNÍ OBLOUKOVÝCH LAVIČEK
ASSEMBLING THE ARCH BENCHES
ZUSAMMENSETZUNG VON DER GEBOGENEN PARKBÄNKE

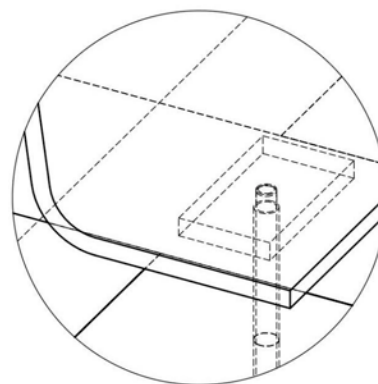
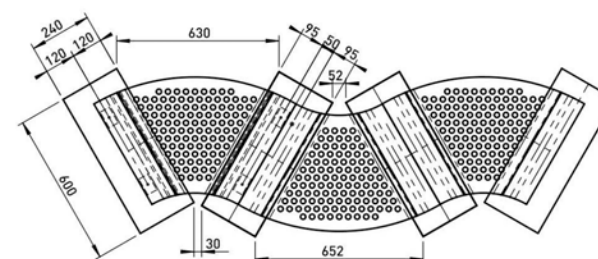

TECHNICAL SPECIFICATIONS 3/5
LSN - SINUS



mmcite.com

Rozměry výrobků mají informativní charakter. Výrobce si vyhrazuje právo na změnu technické specifikace bez předchozího upozornění. Rozměry spodní stavby a způsob osazení výrobku jsou závazné. Rozteče kotev rozměřovat dle rozměrů dodaného výrobku.
All product sizes have an informative character. The Producer reserves the right to amend the technical specification at any time without previous warning. The size of foundation baseplate and the method of mounting of the product are imperative. Anchor spacing measure out by measurements of supplied product.
Die Abmessungen der Produkte sind informativ. Der Hersteller behält sich das Recht an Änderungen der technischen Spezifikationen vor, ohne vorher darauf hinzuweisen. Abmessungen der Fundamentierung - Unterbau und Art des Produkteinbaus sind verbindlich. Ankerabstand gemäß der gelieferten Produktabmessungen dimensionieren.