

DATABLAD

LED FullMatrix VSLS

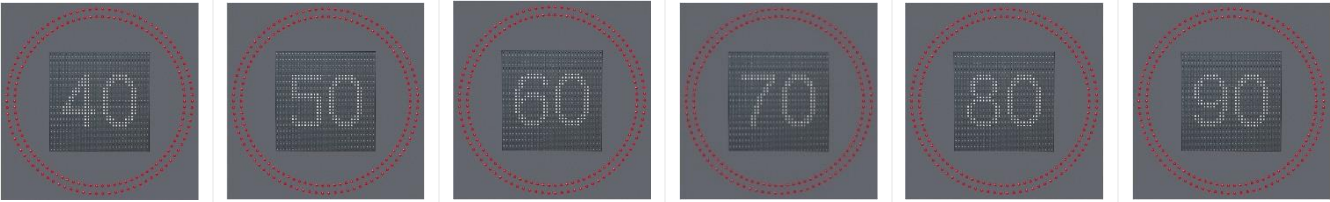





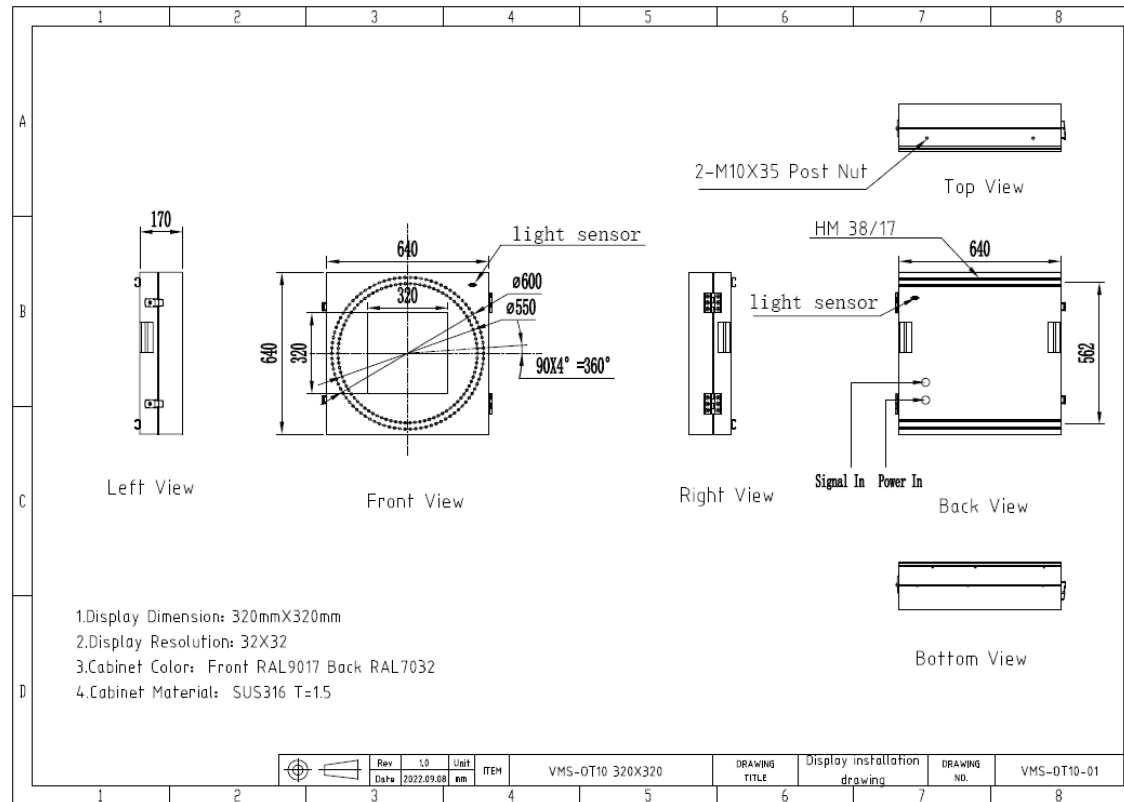





Produktnummer:	16017000045		
Beskrivelse:	LED fartsgrenseskilt, LS, firkantet		
Produktspesifikasjon:			
Mekaniske data			
Kassemål (mm):	640x640	Skilt nr.:	334, 335, 362
Ansiktsmål (mm):	Ø600	Overflatebehandling:	Pulverlakkert; Front: RAL9017 Bakside: RAL 7032 (andre på forespørsel)
Vekt (kg):	25	Temperaturklasse:	T1, T3 (-40°C til +60°C)
Materialtype:	Syrefast, 316L	Kapslingsgrad:	P3 (IP56)
		Forurensningsklasse:	D2
		Service/Vedlikehold:	Via front
		Installasjon:	C-skinne 38/17
			
Optiske data		Tekniske data	
Lyskontroll:	Automatisk, 32 nivåer	Pikselavstand:	10mm
Lysmåler:	Front, bak	Moduloppløsning:	32x16px
Luminans:	L1, L2, L3(L3*)	Modulstørrelse:	320x160mm
Luminans forhold:	R3	Ansiktsmål matrise:	320x320mm
Farger:	C2	Visningsfarge sirkel:	Rød (C2)
LED type:	SMD / 5mm THT	Omkrets ringer:	Ø600, Ø550
Spredningsvinkel:	B1, B2, B3, B4, B5, B6	Antall ringer:	2
Klasser:	EN12966 L3/L3*, R3, C2, B6		
Elektriske data			
Nominell spenning:	24V DC		
Kabelgjennomføring:	1 stk M25, 1 stk M20		
LED kort spenning:	5V DC		
Effektforbruk Nom/Maks:	20W / 50W		
Styring og overvåkning:	12xDirekte I/O (andre på forespørsel)		
EMC Sertifisering:	I overensstemmelse med EN50293		
Sertifisering:	EN12966:2005+A1:2009 Sertifisert av INSTITUTO GIORDANO		
Styring (opt):	Prod.nr.: 16016010054 Modbus TCP/IP	Prod.nr.: 16016010055 Profibus	
	Prod.nr.: 16016010010 OPC-UA LINUX		
Drift / Vedlikehold:	Se egen vedlikeholds manual		

DATABLAD

LED FullMatrix VLSL



Figur 1: Sammenstillingstegning (GA)

Posisjon:	Posisjon 0	Posisjon 1	Posisjon 2	Posisjon 3	Posisjon 4	Posisjon 5	Posisjon 6	Posisjon 7	Posisjon 8	Posisjon 9	Posisjon 10	Posisjon 11	Posisjon 12
Visning:	Mørk	334	335	362.30	362.40	362.50	362.60	362.70	362.80	362.90	362.100	362.110	Ledig
.bmp:	000	001	002	003	004	005	006	007	008	009	010	011	012
													TBA

Figur 2: VLSL-visninger