

Reforma-serien

Benker og seter med og uten rygg

Tunge, robuste benker med betongfundament tenkt på nye måter. Modernisert form på ben gjør serien mer anvendelig på nåtidens byrommet enn de gamle variantene av denne typen benk vi alle kjenner til fra før. To typer benker med ryggstøtte, samt benker uten rygg i rette eller buete former. Seter uten rygg kan også monteres på eksisterende murkanter av granitt eller betong.

Alle stådelene er av galvanisert eller rustfritt stål. Alle modellene er for overflatemontering/for bolting på fast dekke/betong.

Trespilene leveres enten i varmebehandlet ask (Thermoask), akasia (europeisk, aka robinia) eller FSC godkjent Jatoba. Spilene er montert enten tvers- eller langsgående på benkene. Ben av HSC betong (High strength concrete). Betongdelene enten i lys eller mørk grå farge.

Design: Vrliška & Žák

Produsent: mmcité



Reforma-serien

REF110. Benk uten rygg, L 180 cm. Langsgående trespiler og ben av betong. Betongfarge: lys eller mørke grå.

Vektseksempler: REF110 r 107 kg og REF110 t 111 kg

Art.nr

75000026010	REF110 t, 1,8m benk u rygg, FSC jatoba, lys grå betong
75000026020	REF110 t, 1,8m benk u rygg, FSC jatoba, mørk grå betong
75000026030	REF110 r, 1,8m benk u rygg, akasia, lys grå betong
75000026040	REF110 r, 1,8m benk u rygg, akasia, mørk grå betong
75000026050	REF110 j, 1,8m benk u rygg, thermoask, lys grå betong
75000026060	REF110 j, 1,8m benk u rygg, thermoask, mørk grå betong

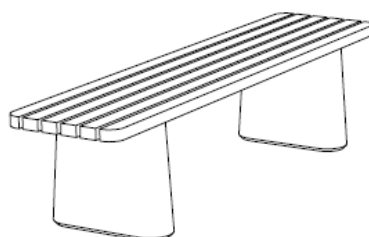
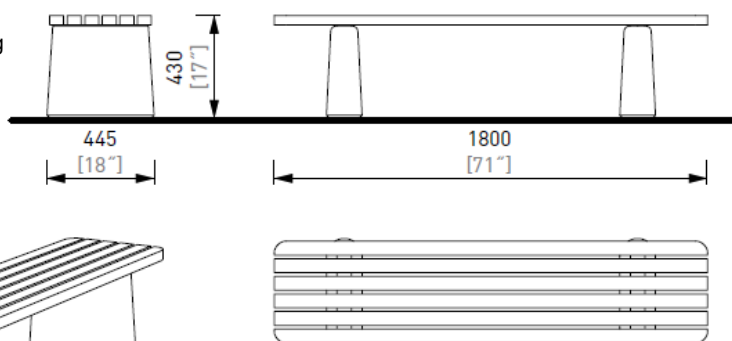

REF111/112/113. Benk uten rygg, tot L 424 cm. Langsgående trespiler og ben av betong. Venstre-, mellomste- og høyremodul.

Vektseksempler: REF111 r / REF112 r / REF113 r total vekt: 224 kg

REF111 t / REF112 t / REF113 t total vekt 233 kg

Art.nr

Art.nr	REF111 tilsv. treverk/farge	REF112 tilsv. treverk/farge	REF113 tilsv. treverk/farge
75000026100	REF111 t, 1,5m venst avsl.benk u rygg, FSC jat., lys grå bet.	75000026200	75000026300
75000026110	REF111 t, 1,5m venst avsl.benk u rygg, FSC jat., mørk grå	75000026210	75000026310
75000026120	REF111 r, 1,5m venst avsl.benk u rygg, akasia, lys grå bet.	75000026220	75000026320
75000026130	REF111 r, 1,5m venst avsl.benk u rygg, akasia, mørk grå	75000026230	75000026330
75000026140	REF111 j, 1,5m venst avsl.benk u rygg, th.ask, lys grå bet.	75000026240	75000026340
75000026150	REF111 j, 1,5m venst avsl.benk u rygg, th.ask., mørk grå	75000026250	75000026350

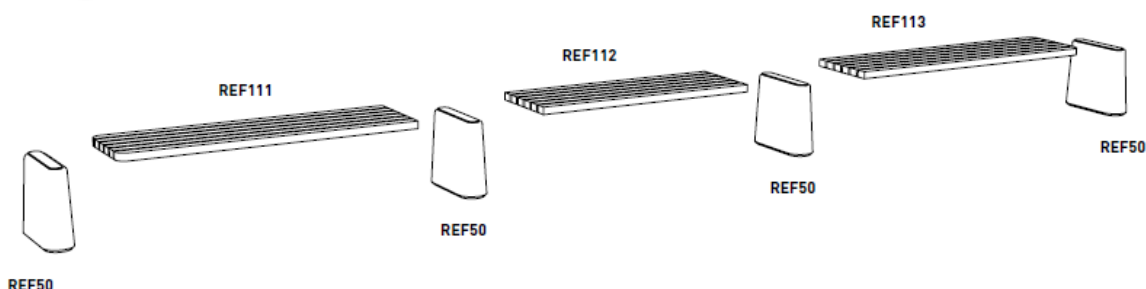
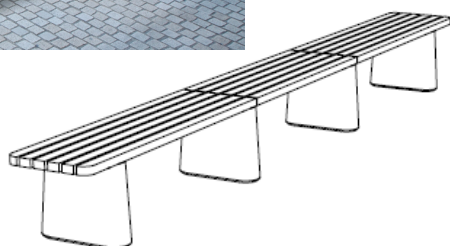
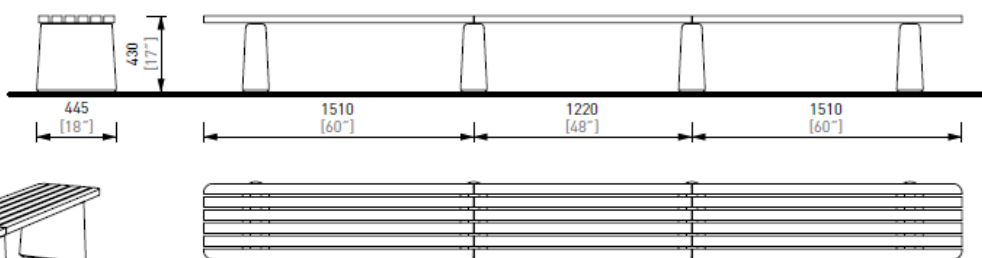

Reforma-serien

REF150. Benk med rygg, L 180 cm. Åpning i ryggen. Langsgående trespiler og ben av betong.

Vektseksempler: REF150 r 183kg og REF150 t 188 kg

Art.nr

75000026400	REF150 t, 1,8m benk m rygg sep.fra sete, FSC jat. lys grå be
75000026410	REF150 t, 1,8m benk m rygg sep.fra sete, FSC jat. mørk grå
75000026420	REF150 r, 1,8m benk m rygg sep.fra sete, akasia, lys grå be
75000026430	REF150 r, 1,8m benk m rygg sep.fra sete, akasia, mørk grå
75000026440	REF150 j, 1,8m benk m rygg sep.fra sete, th.ask, lys grå be
75000026450	REF150 j, 1,8m benk m rygg sep.fra sete, th.ask, mørk grå

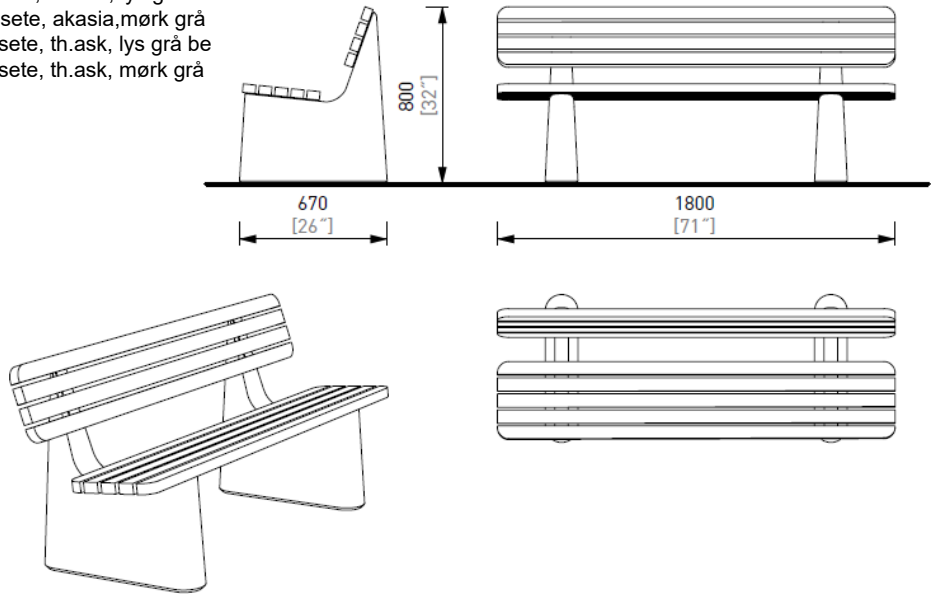

REF170. Benk med rygg, L 180 cm. Sammenhengende rygg og sete. Langsgående trespiler og ben av betong.

Vektseksempler: REF170 r 196 kg og REF170 t 203 kg.

Art.nr

75000026500	REF170 t, 1,8m benk m rygg, FSC jatoba, lys grå betong
75000026510	REF170 t, 1,8m benk m rygg, FSC jatoba, mørk grå betong
75000026520	REF170 r, 1,8m benk m rygg, akasia, lys grå betong
75000026530	REF170 r, 1,8m benk m rygg, akasia, mørk grå betong
75000026540	REF170 j, 1,8m benk m rygg, thermo ask, lys grå betong
75000026550	REF170 j, 1,8m benk m rygg, thermo ask, mørk grå betong

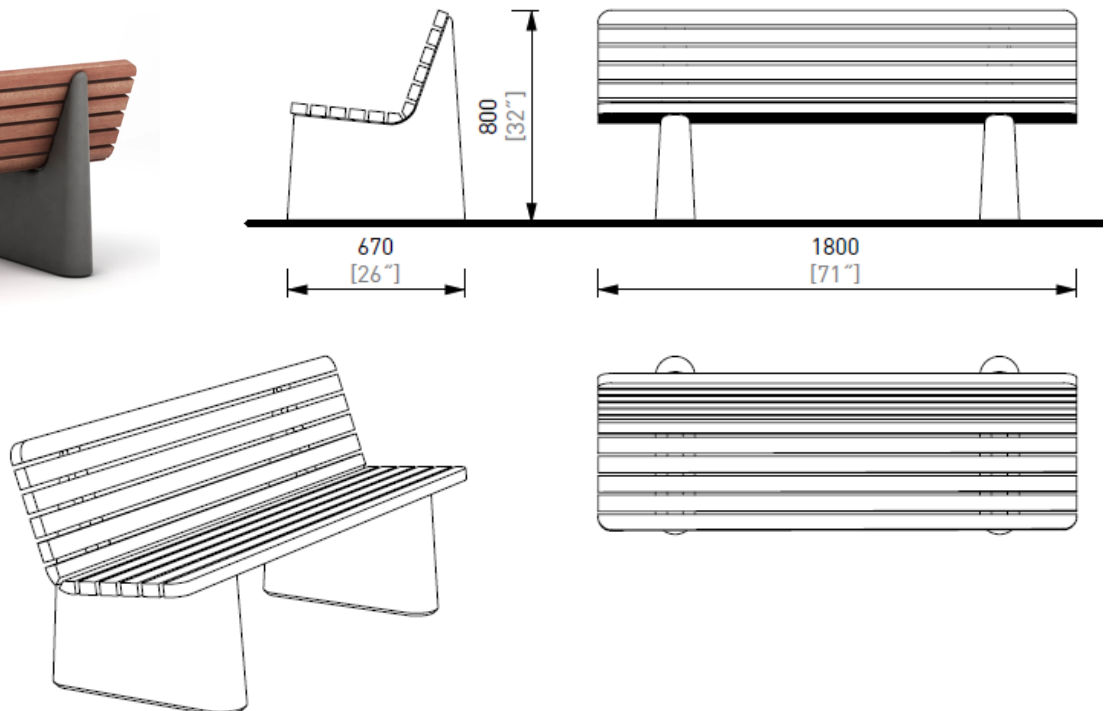

Reforma-serien

REF210. Benk uten rygg, L 180 cm. Tversgående trespiler og ben av betong.

Vektseksempler: REF210 r 117 kg og REF210 t 121 kg

Art.nr

75000026600	REF210 t, 1,8m benk u rygg, tversg. FSC jatoba, lys grå bet
75000026610	REF210 t, 1,8m benk u rygg, tversg. FSC jatoba, mørk grå bet
75000026620	REF210 r, 1,8m benk u rygg, tversg. akasia, lys grå bet
75000026630	REF210 r, 1,8m benk u rygg, tversg. akasia, mørk grå bet
75000026640	REF210 j, 1,8m benk u rygg, tversg. thermoask, lys grå bet
75000026650	REF210 j, 1,8m benk u rygg, tversg. thermoask, mørk grå bet

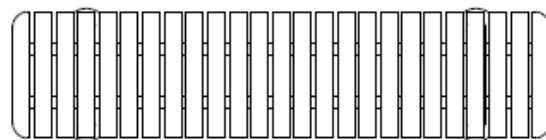
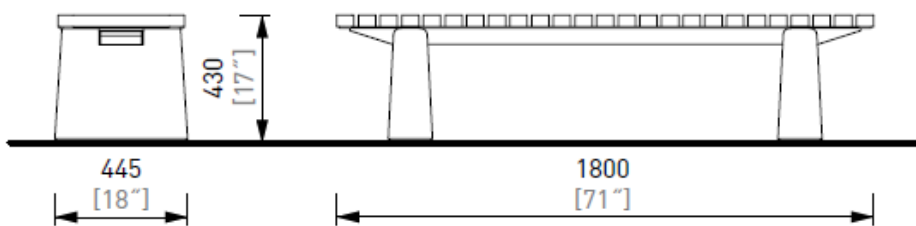
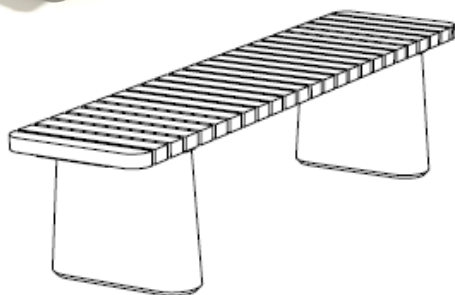
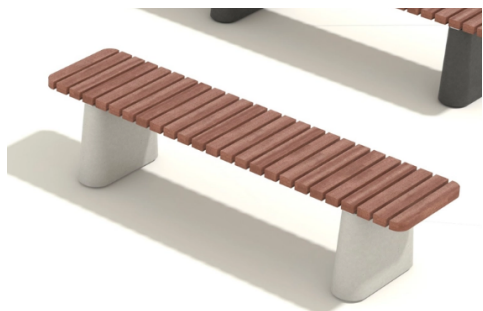

REF211/212/213. Benk uten rygg, tot L 424 cm. Tversgående trespiler og ben av betong. Venstre-, midt- og høyremodul.

Vektseksempler: REF211 r / REF212 r / REF213 r total vekt: 248 kg

REF211 t / REF212 t / REF213 t total vekt 257 kg

Art.nr

75000026700	REF211 t, 1,5m venst avsl.benk u rygg, FSC jat., lys grå bet.
75000026710	REF211 t, 1,5m venst avsl.benk u rygg, FSC jat., mørk grå
75000026720	REF211 r, 1,5m venst avsl.benk u rygg, akasia, lys grå bet.
75000026730	REF211 r, 1,5m venst avsl.benk u rygg, akasia, mørk grå
75000026740	REF211 j, 1,5m venst avsl.benk u rygg, th.ask, lys grå bet.
75000026750	REF211 j, 1,5m venst avsl.benk u rygg, th.ask., mørk grå

Tilsv.tre/farge REF212

Tilsv.tre/farge REF213

75000026810
75000026820
75000026830
75000026840
75000026850
75000026860

75000026910
75000026920
75000026930
75000026940
75000026950
75000026960

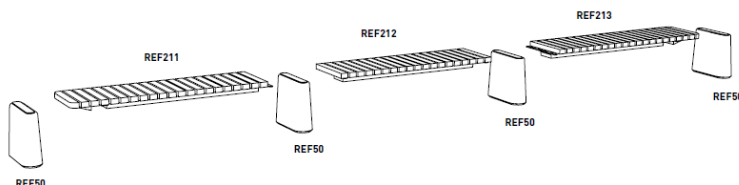
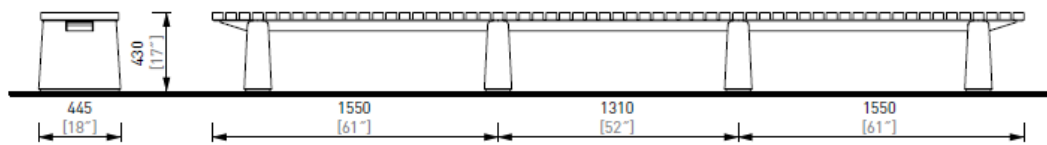
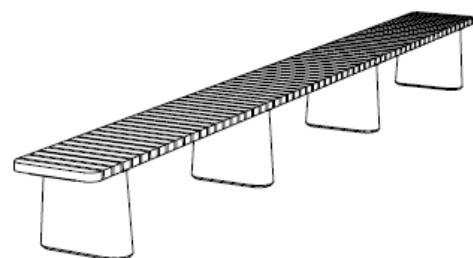

Reforma-serien

REF310. Sete uten rygg, L 180 cm. Langsgående trespiler, for eksisterende murkanter o.l.

Art.nr	
75000027010	REF310 t sete 1,8m, FSC jatoba, for eksisterende murkant
75000027020	REF310 r sete 1,8m, akasia, for eksisterende murkant
75000027030	REF310 j sete 1,8m, thermo ask, for eksisterende murkant

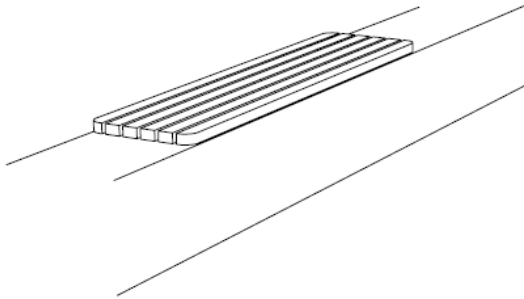
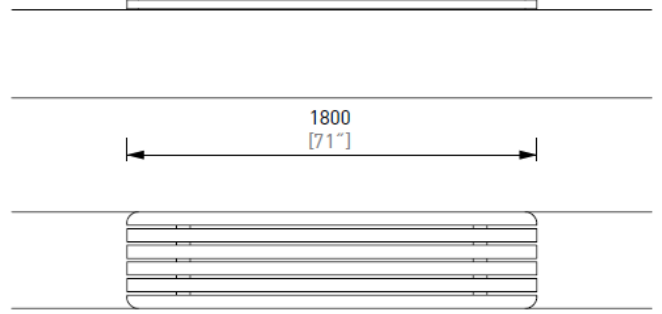
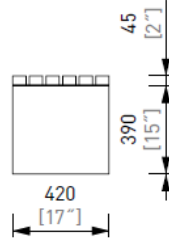
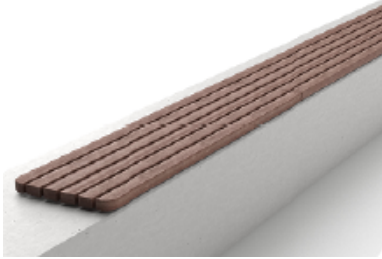

REF311/312/313. Seter uten rygg, tot L 424 cm. Langsgående trespiler, for eksisterende murkanter o.l. Venstre-, midt- og høyre modul.

Art.nr		Tilsv. REF312	Tilsv. REF313
75000027110	REF311 t sete 1,5m, FSC jat., venstre ende, for eks.murkant	75000027210	75000027310
75000027120	REF311 r sete 1,5m, akasia, venstre ende, for eks.murkant	75000027220	75000027320
75000027130	REF311 j sete 1,5m, thr.ask, venstre ende, for eks.murkant	75000027230	75000027330

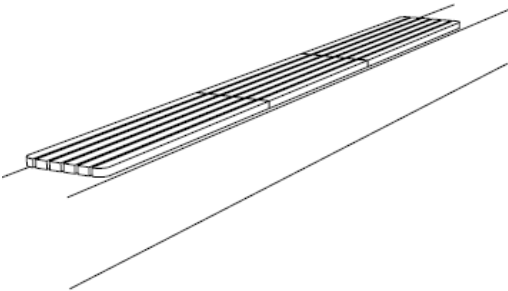
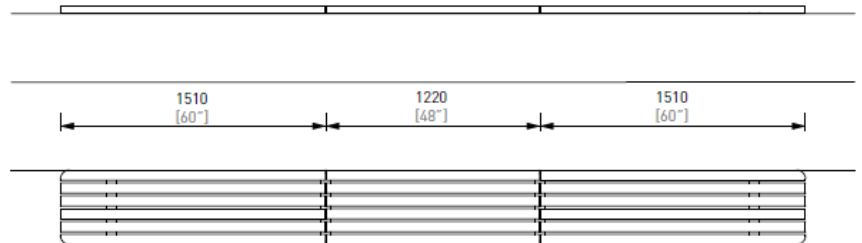
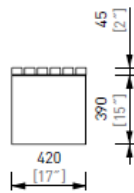

Reforma-serien

REF410. Sete uten rygg, L 180 cm. Tversgående trespiler, for eksisterende murkanter o.l.

Art.nr	
75000027410	REF410 t sete 1,8m, FSC jatoba, for eksisterende murkant
75000027420	REF410 r sete 1,8m, akasia, for eksisterende murkant
75000027430	REF410 j sete 1,8m, thermo ask, for eksisterende murkant

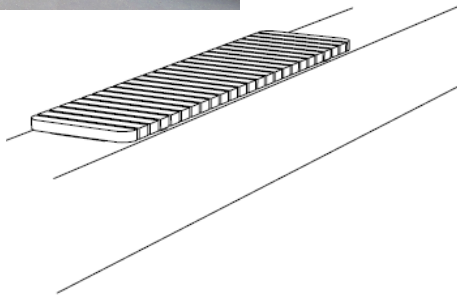
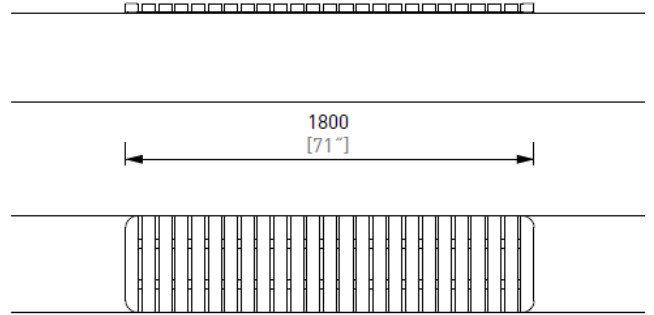
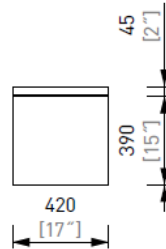

REF411/412/413. Seter uten rygg, tot L 442 cm. Tversgående trespiler, for eksisterende murkanter o.l. Venstre-, midt- og høyre modul.

Art.nr		Tilsv.REF412	Tilsv.REF413
75000027510	REF411 t sete 1,6m, FSC jat., venstre ende, for eks.murkant	75000027610	75000027710
75000027520	REF411 r sete 1,6m, akasia, venstre ende, for eks.murkant	75000027620	75000027730
75000027530	REF411 j sete 1,6m, thr.ask, venstre ende, for eks.murkant	75000027630	75000027730

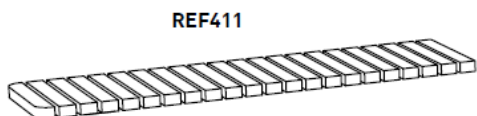
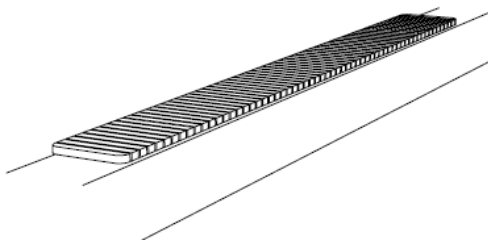
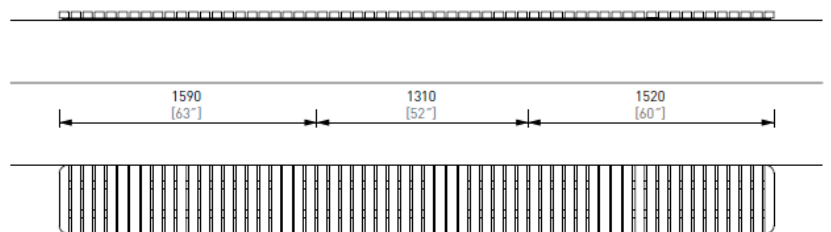
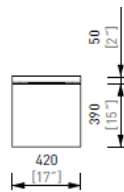

REF411



REF412

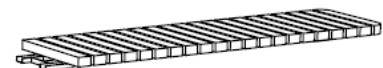

REF413

Reforma-serien

REF610. Buet benk uten rygg, L 201 cm. Tversgående trespiler.

Art.nr

- | | |
|-------------|--|
| 75000027810 | REF610 t buet benk u rygg 2 m, FSC jat., lys grå betong |
| 75000027820 | REF610 t buet benk u rygg 2 m, FSC jat., mørk grå betong |
| 75000027830 | REF610 r buet benk u rygg 2 m, akasia, lys grå betong |
| 75000027840 | REF610 r buet benk u rygg 2 m, akasia, mørk grå betong |
| 75000027850 | REF610 j buet benk u rygg 2 m, thermo ask, lys grå betong |
| 75000027860 | REF610 j buet benk u rygg 2 m, thermo ask, mørk grå betong |

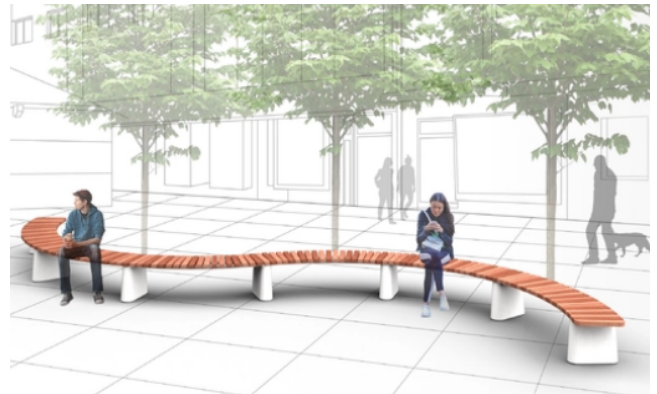
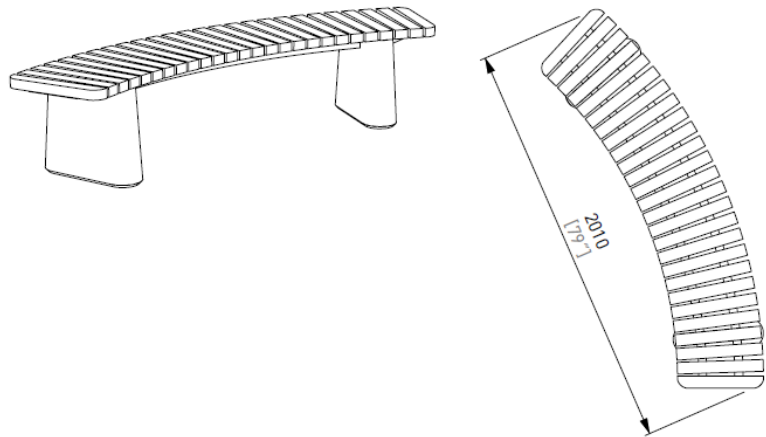
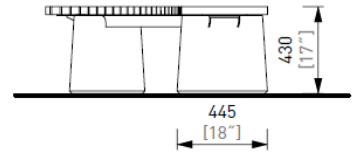

red**dot** winner 2022
urban design

**REFORMA
ROLLS!**

Reforma-serien

REF611 /612 /613 /614 /615. Modulbenk-system uten rygg. Tversgående trespiler med betongben REF50. Venstre-, midt- og høyre moduler. Mange variasjonsmuligheter.

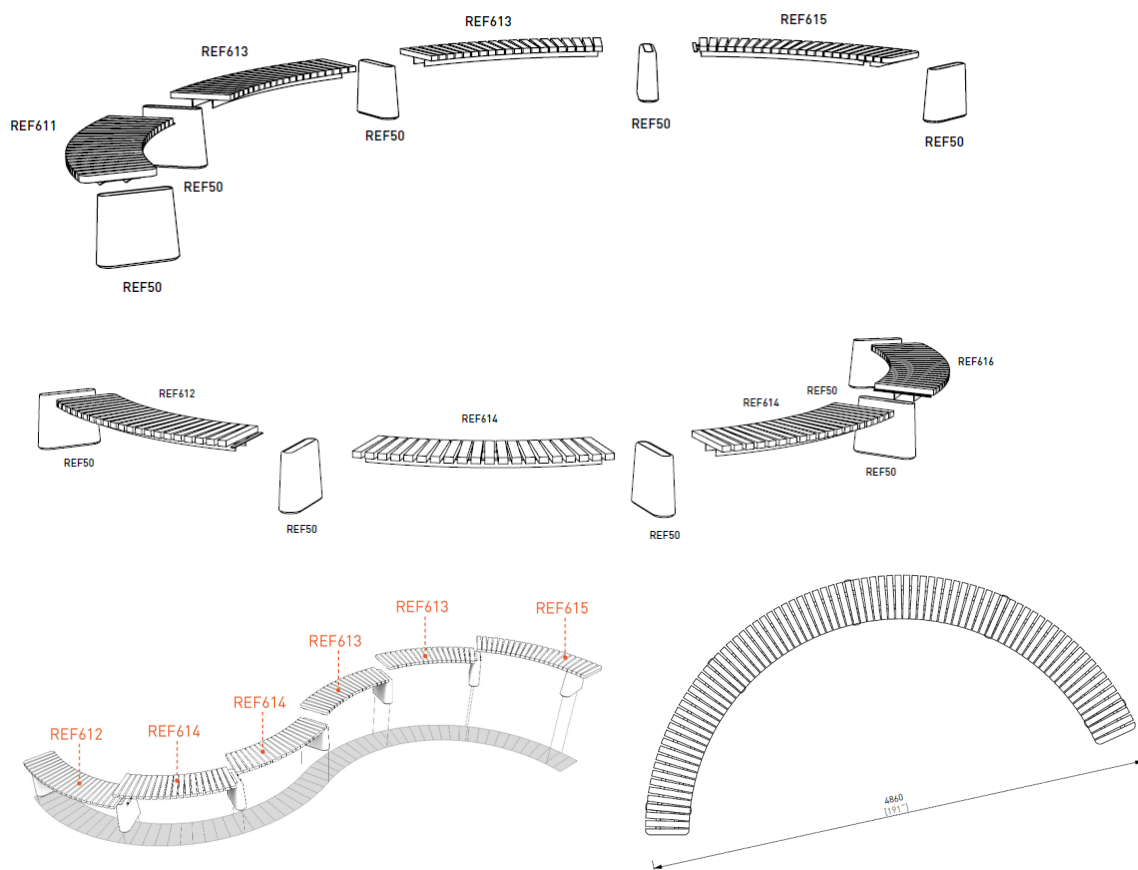

DATE: 22

Art.nr	
75000027910	REF611 t buet benk u rygg 1,5 m, FSC jat., venst., lys grå
75000027920	REF611 t buet benk u rygg 1,5 m, FSC jat., venstre, mørk grå
75000027930	REF611 r buet benk u rygg 1,5 m, akasia, venstre, lys grå
75000027940	REF611 r buet benk u rygg 1,5 m, akasia, venstre, mørk grå
75000027950	REF611 j buet benk u rygg 1,5 m, th.ask, venstre, lys grå
75000027960	REF611 j buet benk u rygg 1,5 m, th.ask, venstre, mørk grå

75000028210	REF614 t buet benk u rygg 1,5 m, FSC jat., senter, lys grå
75000028220	REF614 t buet benk u rygg 1,5 m, FSC jat., senter, mørk grå
75000028230	REF614 r buet benk u rygg 1,5 m, akasia, senter mod, lys grå
75000028240	REF614 r buet benk u rygg 1,5 m, akasia, senter, mørk grå
75000028250	REF614 j buet benk u rygg 1,5 m, thr.ask, senter mod, lys grå
75000028260	REF614 j buet benk u rygg 1,5 m, thr.ask, senter, mørk grå

Tilsv.REF612	Tilsv.REF613
75000028010	75000028110
75000028020	75000028120
75000028030	75000028130
75000028040	75000028140
75000028050	75000028150
75000028060	75000028160

Tilsv. REF615	Tilsv. REF616
75000028310	75000028410
75000028320	75000028420
75000028330	75000028430
75000028340	75000028440
75000028350	75000028450
75000028360	75000028460

Materiale: HSC betong på ben.

Trespiler av uoljet varmebehandlet ask (Thermoask, j), Akasia (Robinia, r) eller FSC godkjent Jatoba (t).
Mot tillegg på prisen kan disse leveres også oljet.

Farger: Mørk eller lys grå farge på betong.

Fastsetting: Frittstående eller boltes fast på fastdekke/betong.